

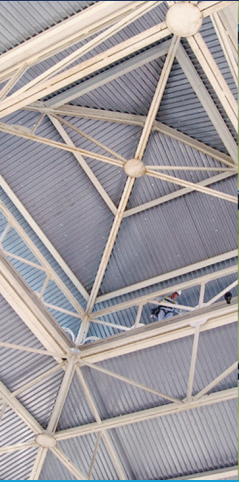

# Bird-X Installer Catalog

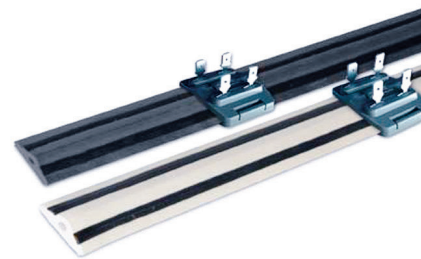

*Bird Netting*  
*Bird Spikes*  
*Avishock™*  
*Bird Wire*  
*Netting Hardware*  
*Other Bird Repellent Products*

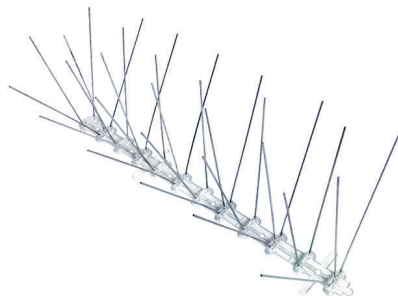

# Contents

- 3 [About Bird-X](#)
- 4 [Bird Netting](#)  
Exclusion netting prevents pest birds from entering specific areas – when installed properly is 100% effective.
- 5 [Netting Hardware](#)  
Commercial-grade hardware needed to install Bird-X BirdNet – cables, screws, nuts, brackets, turnbuckles, ferrules, and more.
- 7 [Bird Spikes](#)  
Bird spikes protect surfaces from pest bird infestation. Available in Stainless Steel or Plastic. Available in multiple lengths, heights, and widths.
- 9 [Avishock™, Hardware & Chargers](#)  
Avishock™ gives a mild electric shock when touched, conditioning birds to stay away from treated surfaces.
- 11 [Bird Wire & Post Products](#)  
Bird Wire is great for high-profile ledges where a less visible solution is needed; wires are installed at differing heights making it difficult for birds to land.
- 12 [Other Bird Repellent Products](#)  
Bird Proof Gel and liquids, taste aversions, visual scares, predator decoys, and more.
- 13 [Pigeon & Sparrow Traps](#)  
Durable, humane, and effective multi-catch bird traps.
- 14 [OvoControl®](#)  
Humane population control bird feed with automated feeder.
- 15 [Sonic & Ultrasonic Electronic Bird Repellers](#)  
Electronic repellers provide effective, money-saving, humane bird control solutions.
- 16 [Bird Balls](#)  
Floating ball blankets for water applications; full coverage and eco-friendly.
- 17 [Indoor & Outdoor Laser Bird Control](#)  
Colored laser beams frighten and deter birds for up to 10,000 sq. ft.
- 18 [ProHawk UAV Drone](#)  
The first manual or autonomous drone of its class made specifically for bird control.

# About Bird-X

Bird-X is the leading brand of humane pest and bird control solutions worldwide, protecting human health, wildlife and the environment in which we all live.

Established in 1964, the Chicago-based company manufactures a complete line of unique pest control products with an unmatched focus on quality, efficacy and customer service.

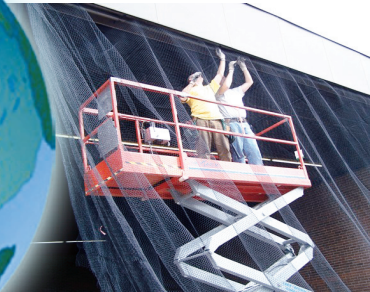

***Humane & Eco-friendly Solutions***  
***Experienced Sales Consultants***  
***Unmatched Quality***  
***Worldwide Distribution***  
***Outstanding Customer Service***

**Ask about becoming a Preferred Bird-X Installer!**



**USA Headquarters**  
**(+1) 312.226.2473**  
**[solutions@bird-x.com](mailto:solutions@bird-x.com)**

**UK & Ireland**  
**+44 (0) 1903 715 631**  
**[sales@bird-x.co.uk](mailto:sales@bird-x.co.uk)**

**European Office**  
**+31 (0) 548 659 016**  
**[europe@birdx.eu](mailto:europe@birdx.eu)**

# Bird Netting

Bird Netting creates a physical barrier to prevent pest birds from entering specific areas. When installed properly, netting is 100% effective, making it ideal for zero-tolerance zones. It can be used to block pest bird access in many applications.

## PE-Plus Premium Grade BirdNet

This 3/4" polyethylene netting is a permanent solution, ideal for commercial projects. The material is light-weight, pliable, maintenance-free, and durable – 10 year warranty!

*\*Bird-X can provide custom cut sizing to fit your needs.*

### 3/4" Black Polyethylene Knotted Net

25'x25'.....625 sq. ft....[NET-PE-25-25](#)

25'x50'....1,250 sq. ft....[NET-PE-25-50](#)

50'x50'....2,500 sq. ft....[NET-PE-50-50](#)

50'x100'..5,000 sq. ft....[NET-PE-50-100](#)

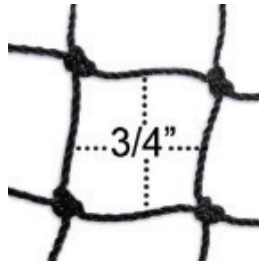

### 2" Black Polyethylene Knotted Net

25'x25'.....625 sq. ft....[NET-PE-25-25-2](#)

25'x50'....1,250 sq. ft....[NET-PE-25-50-2](#)

50'x50'....2,500 sq. ft....[NET-PE-50-50-2](#)

50'x100'..5,000 sq. ft....[NET-PE-50-100-2](#)

### 3/4" Stone Polyethylene Knotted Net

25'x25'.....625 sq. ft....[NET-PE-25-25-STONE](#)

25'x50'....1,250 sq. ft....[NET-PE-25-50-STONE](#)

50'x50'....2,500 sq. ft....[NET-PE-50-50-STONE](#)

50'x100'..5,000 sq. ft....[NET-PE-50-100-STONE](#)



### 1-1/8" Black Polyethylene Knotted Net

25'x25'.....625 sq. ft....[NET-PE-25-25-1-1/8](#)

25'x50'....1,250 sq. ft....[NET-PE-25-50-1-1/8](#)

50'x50'....2,500 sq. ft....[NET-PE-50-50-1-1/8](#)

50'x100'..5,000 sq. ft....[NET-PE-50-100-1-1/8](#)

This 1/2" polypropylene netting is perfect for small businesses, homeowners, farmers and gardeners. It is tough, plastic netting that is light-weight, pliable, and resistant to elemental damage – lasts up to 5 years!

*\*Bird-X can provide netting lengths up to 5,000 feet!*

### 1/2" Black Polypropylene Net

100'x14'...1,400 sq. ft.....[NET-STR-100](#)

200'x14'...2,800 sq. ft.....[NET-STR-200](#)

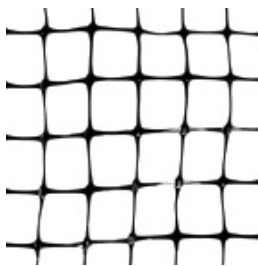

## Structural Heavy-Duty BirdNet

This 3/4" standard mesh netting is a great economical solution for homeowners and gardeners. It is light-weight, pliable and weatherproof.

*\*Bird-X can provide netting lengths up to 5,000 feet!*

### 3/4" Black Polypropylene Net

100'x14'...1,400 sq. ft.....[NET-STD-100-14](#)

200'x14'...2,800 sq. ft.....[NET-STD-200-14](#)



## Standard BirdNet

Each job is different and demands some on-site ingenuity. It can be very difficult to install properly if each step isn't carefully thought out. Double-check your measurements before cutting the net and be sure you have all materials necessary to complete the job before beginning.

**\*Call your account manager with any questions.**

# Netting Hardware



## Bird Netting Install Overview:

Corner/Primary attachments are under the most pressure and must be the strongest component in the system; be sure all attachments are firmly anchored. Be sure to install attachments every 45-50 feet for large jobs.

*Wood: use galvanized/stainless*

*Concrete: use expanding net bolts*

*Steel: use eye bolts and nuts*

## Intermediate Attachments:

These hold the cable tight against the structure to prevent bowing (giving birds room to enter/exit the area of coverage). Intermediate attachments should be installed every 20-25 feet. Smaller birds (such as sparrows and swallows) require intermediate attachments every 2 feet. These can be used for wood or concrete frames.

## Stringing Wire/Cable & Ferrules:

The perimeter cable frames the entire area to be sectioned off by the netting. Ferrules secure the cables where they attach to the corner attachments. Slide the ferrules onto the cable before you form your connecting loop and secure it to the cable with the ratchet tool. Be sure there are at least two ferrules per loop to ensure strength and durability of the perimeter cable.

## Turnbuckles:

Turnbuckles also must be well anchored as they are subject to a great deal of tension between the cable and the corner attachments – be sure your components are well secured. When installing, make sure the turnbuckles are all the way open. Pull the cable as tight as possible through the turnbuckle. Before tightening, be sure all slack in the cable is removed, taking up as much tension as possible and fasten with a screwdriver, etc. Be sure not to pull out any fasteners or eyehooks when tightening.



## Mounting Cable

**Stainless Steel**

500' Spool – 3/32", 49 Strand Cable  
Cable, 7x7, 3/32" (2mm) diameter with 920 lb. tensile.

**MTG-CABLE-SS**



## Eyebolt Screw

For wood or thick sheet metal surfaces.

**Stainless Steel (20 pack)**

Corner/end attachment. 17/32" I.D., 1" lag thread.

**MTG-SCREW-MD-SS**



## Eyebolt w/Nut

Corner/end attachment for an I-beam or other thick metal.

**Stainless Steel (10 pack)**

**Galvanized (10 pack)**

**MTG-BOLT-MD-SS**

**MTG-BOLT-MD**



## Net Concrete Spikes

This hammer-in attachment is the strongest attachment for stone, concrete or solid brick. It does not require a plastic anchor sleeve; the bent shaft holds it securely in place. Zinc coated.

**Stainless Steel Net Spikes, Small (100 pack)**

**MTG-SPIKES-SS**

**Galvanized Net Spikes, Small (100 pack)**

**MTG-SPIKES**



## Eyebolt Anchor

Corner/end attachment. M6 high load bearing expansion bolt anchor. For most masonry, stone, or concrete. This M6 netbolt needs a 14mm drill bit.

**Stainless Steel (10 pack)**

**MTG-NETBOLT-MD-SS**

# Netting Hardware Continued

## Multi-Purpose Cable Bracket

1.25" bracket is used as an end or intermediate bracket and installed as either a permanent fixture or as a quick-release cable holder.

**Stainless Steel (100 pack)**

**MTG-BRACKET-SS**



## Heavy Duty Steel Clamp. 3/32"

This clamp defines the term "heavy duty". Your best bet for larger net installation, this clamp can hold up to 630 pounds of tensioned weight. Bolt to an I-beam or other steel structure and run your cable inside the jaws. Opens up to 2".

**Stainless Steel Clamp (4 pack)**

**MTG-CLAMP-SS**

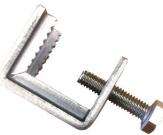

## Girder Clip

This strong, hammer-on clip allows you to attach cable to hard-to-drill steel beams. Hammer the clip into the edge of an I-beam with the cable running through the jaws (not through the hole), and your cable is secure.

**1/8"-1/4" (100 pack)**

**MTG-GIRD-1**

**5/16"-1/2" (100 pack)**

**MTG-GIRD-2**

**9/16"-3/4" (100 pack)**

**MTG-GIRD-4**



## Turnbuckles

Hook-and-eye turnbuckles for tensioning Net Cable.

**Stainless Steel Turnbuckles (10 pack)**

Medium, 1/4" x 3-1/2"

**MTG-TURN-SM-SS**

**MTG-TURN-MD-SS**

**MTG-TURN-LG-SS**



## Ferrules, 2.5MM

Double Sleeve Zinc/Copper Ferrules. For connecting short cable runs (3/32"). Ratchet Crimper required.

**Copper (100 pack)**

**MTG-FERR-C**

**Aluminum (100 pack)**

**MTG-FERR**



Two (2) ferrules per cable connection.

## Bracket with Hilti Pin

Used as a corner or intermediate attachment or as a quick-release cable holder.

**MTG-BRACKET-HILTI PIN**



## Net Ring Tool

Hand operated, auto-feed ring tool. Installs net rings around net, cable, zippers, etc.

**MTG-RING-TOOL**



## Net Rings

Net rings secure seams and fasten the netting to the cable, zippers, etc. Ring Tool required.

**Stainless Steel (2,500 pack)**

**MTG-RINGS-SS**



## Net Access Clip

Connect pieces of netting together securely with stainless steel clips.

**3/4" Stainless Steel (100 pack)**

**MTG-ACCESS-CLIP**



**2" Stainless Steel (100 pack)**

**MTG-ACCESS-CLIP2**

## Net Zipper

UV resistant black zipper. Fasten to netting with net rings and ring tool.

**1' Black, 5MM**

**MTG-ZIPPER-1**

**3' Black, 5MM**

**MTG-ZIPPER3**

**6' Black, 5MM**

**MTG-ZIPPER**



**Custom size**

**MTG-ZIPPER-C**

## Net Ratchet Crimp Tool

Hand operated, ratcheting crimper for ferrules.

**MTG-RATCHET**



## Pneumatic Ring Tool

16 gauge 3/4" C-Ring. Magazine capacity of 125.

**1/2" tool also available**

**MTG-PN-RINGTOOL-3/4**



Bird-X Stainless Steel Bird Spikes are used on structures worldwide to keep pest birds from roosting and nesting on building surfaces. The spikes are not harmful – just extremely irritating, intimidating, and uninviting.

Stainless Steel Bird Spikes are the industry standard on public and private RFPs. They won't corrode or decay and the flexible base allows for installation on curved surfaces.

Various sizes available. CAD files and documented specifications available upon request.

# Stainless Steel Bird Spikes

## Narrow Bird Spikes 2.5"

- Top width: 2.5"**
- Base width: 0.5"**
- Highest point: 4.3"**
- 10 ft.....**SLS-10**
- 24 ft.....**SLS-24**
- 50 ft.....**SLS-50**
- 100 ft.....**SLS-100**

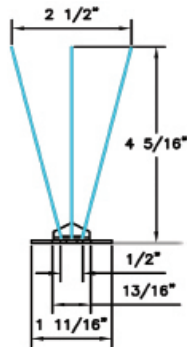

## Regular Bird Spikes 4.5"

- Top width: 4.5"**
- Base width: 0.5"**
- Highest point: 4.3"**
- 10 ft.....**STS-10**
- 24 ft.....**STS-24**
- 50 ft.....**STS-50**
- 100 ft.....**STS-100**

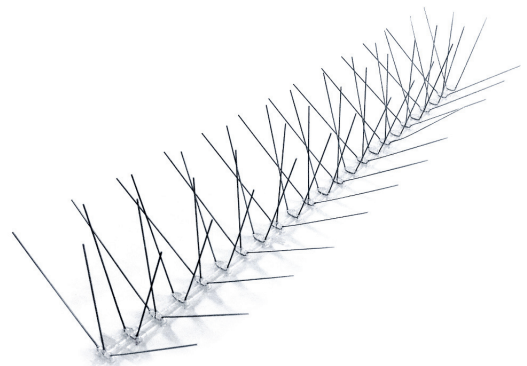
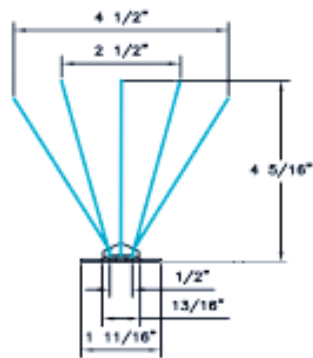

## Extra Wide Bird Spikes 7.5"

- Top width: 7.5"**
- Base width: 0.5"**
- Highest point: 4.3"**
- 10 ft.....**EWS-10**
- 24 ft.....**EWS-24**
- 50 ft.....**EWS-50**
- 100 ft.....**EWS-100**

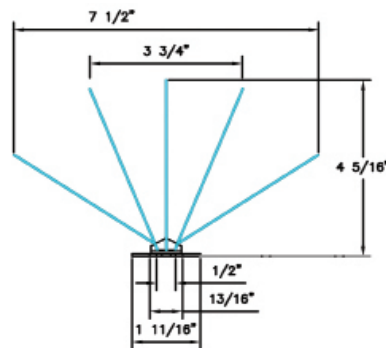

### Special Adhesive

Designed for installing Bird-X Bird Spikes. One (1) tube adheres 15-20 feet of spikes. *Weatherproof; works on a wide range of material.*

**10.5 oz. tube**

**SSA**



## Extra Tall Bird Spikes 7"

- Top width: 7"**
- Base width: 0.5"**
- Highest point: 5.75"**
- 98 ft.....**ETS-98**

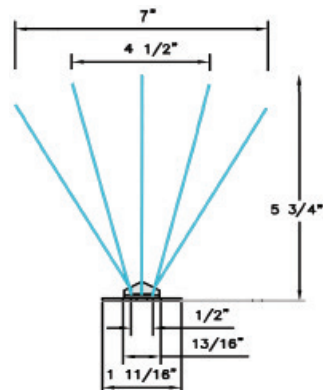

Bird-X Plastic Bird Spikes are made of durable polycarbonate which will not corrode or decay. Bird Spikes eliminate landing surfaces and increase property aesthetics. The flexible base allows for easy installation on curved surfaces.

CAD files and documented specifications available upon request.

# Plastic Bird Spikes



## Narrow Bird Spikes 2.5"

- Top width: 2.5"
- Base width: 0.75"
- Highest point: 4.75"
- 10 ft.....SLS-10
- 25 ft.....SLS-24
- 50 ft.....SLS-50
- 100 ft. ....SLS-100

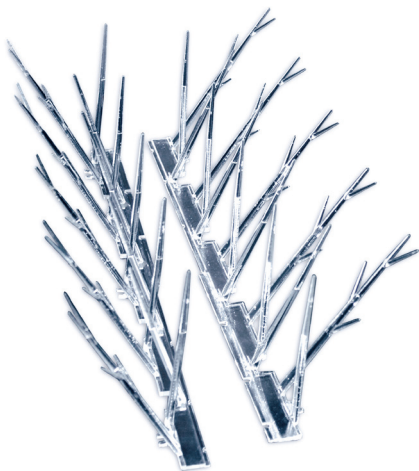

## Regular Bird Spikes 6.5"

- Top width: 4.5"
- Base width: 1.75"
- Highest point: 4.75"
- 10 ft.....STS-10
- 25 ft.....STS-24
- 50 ft.....STS-50
- 100 ft.....STS-100





# Bird Shock Track & Hardware

Avishock™ Bird Shock Track is flexible and adaptable, almost invisible, extremely long-lasting, and humane. It was created with easier and safer installation in mind, featuring snap connectors and longer rolls, no sharp parts to reduce risk of injury, and with a flatter base to help reduce the use of glue. Condition birds to stay away with low-profile electrified track that conforms to any architectural surface.



## Avishock™ Track

Brand new design - low-profile design ideal for preserving building aesthetics.

Fewer energizers (and power sources) are required, making installation very fast and reducing material costs. Flexible track is quick and easy to apply. Less glue is required, saving time and glue expense. Copper strips are covered by a conductive plastic cover, protecting them from harsh weather conditions. Reliable performance over a long period of time due to UV and weather-resistant materials.

Favored by clients, architects, and installers over other solutions, used extensively on heritage sites and challenging building designs as well as modern buildings where aesthetics are most important.

65 ft. Rolls

**Black**  
SHK102

**Stone**  
SHK101

**Grey**  
SHK105

**Brick Red**  
SHK106

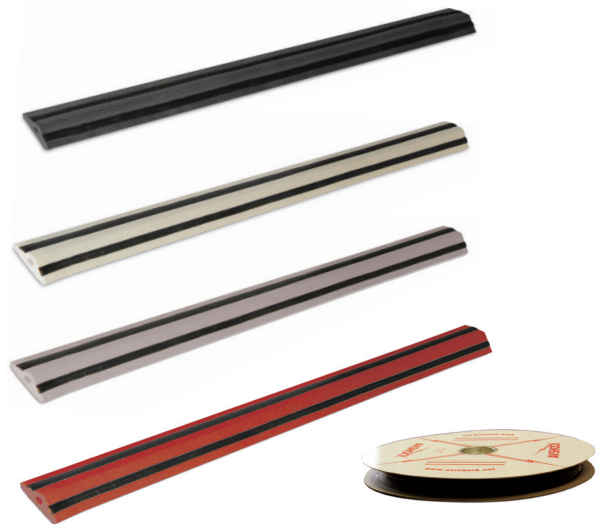

**Straight Connector (x20)**  
SHK121

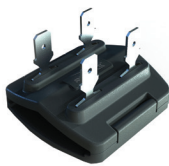

**Corner Connector (x20)**  
SHK122



**Jumper (x20)**  
SHK123



**Female Spade Connectors (x100)**  
SHK023-100



**Male Spade Connectors (x100)**  
SHK029-100



**Connector Ring Terminal (x10)**  
SHK024



# Bird Shock Track Continued

## Special Adhesive

Can be used to adhere Shock Track to a variety of surfaces.

*Weatherproof; works on a wide range of material.*

**10.5 oz. tube**

**SSA**



## Digital Voltage Tester

Used to test that the track is powered. Tester reads in 100v increments up to 10,000. Put one probe to one track braid and the other to the second track braid. The reading should be between 5,000v and 9,000v (5.0 - 9.0kV)

**SHK051**



## Warning Plates (x25)

Hard-wearing plastic

**SHK032**



## Warning Window Stickers (x100)

**SHK033**



## Lead Wire (65')

Heavily insulated, twisted copper is easy to cut, strip and crimp. Used for connecting track to track to energizer.

**Brown: SHK111**

**Black: SHK112**

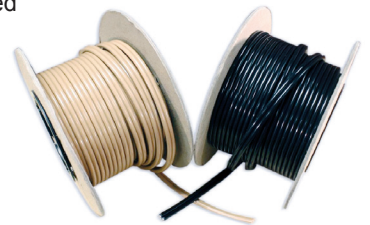

## 12V Battery Charger

300-2,500 ft. of track

**SHK-C-12V**



## Solar Charger

300-2,500 ft. of track

Solar-powered charger with wear resistant case.

**SHK-C-SOL**



## 110V AC Charger

300-1,000 ft. of track

**SHK-C-110**



## Drainage Tubes (100 pack)

To be used anywhere where water pooling is a risk, e.g. flat or gently sloping substrates. Apply enough tubes to allow drainage e.g. 2 tubes every 1 ft.

**SHK130**



## Wire Guides screw on (x100)

**SHK031**



## Wire Guides stick-on (x50)

**SHK034**

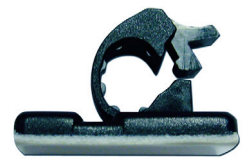

## Avishock™ Shears

Ideal for cutting Avishock™ track and lead wire.

**SHK136**



## Connector Crimp Tool

Used to crimp the connectors to the Lead Wire.

**SHK052**



## Wire Stripping Tool

Used to strip the insulation from the Lead Wire.

**SHK053**

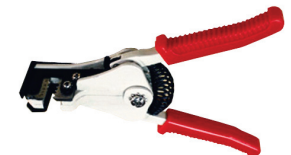

## Avishock™ 45° Cutting Guide

A handy tool to ensure quick and accurate mitre cutting. Simply line up against the track and cut along the edge.

**SHK054**



# Bird Wire & Post Products

Bird Wire is a discreet, humane, and highly-effective bird control solution for ledges, beams, signs and other long surfaces. Stainless steel wires are attached to stainless steel posts at different heights, creating an uneven landing surface and making it difficult – if not impossible – for birds to perch on the treated surface.

## Bird Wire Cable

Stainless steel wire, 1X7 nylon-coated. Diameter is 1mm

250'  
BW-WIRE-250

500'  
BW-WIRE

1,000'  
BW-WIRE-1K



## Posts (100 pack)

Stainless steel posts have flattened heads with hole for wire.

3.5"  
BW-POST-3.5

4.5"  
BW-POST-4.5

5.0"  
BW-POST-5.0

6.0"  
BW-POST-6.0



## Glue-On Bases (10 pack)

Bases can be glued or screwed to surfaces. Posts are inserted in bases.

Black  
BW-BASE-BLACK

Grey  
BW-BASE-GREY

White/Clear  
BW-BASE-WHITE

Tan  
BW-BASE-TAN



## Railing Clamps (10 pack)

Use to attach wire to round surfaces, such as pipes and posts.

1"  
BW-CLAMP-1

2"  
BW-CLAMP-2

3"  
BW-CLAMP-3

4"  
BW-CLAMP-4



## Standard Springs (100 pack)

Easily attach Bird Wire to posts.  
BW-SPRING



## Micro Springs (100 pack)

Easily attach Bird Wire to posts (more subtle than the standard size).  
BW-SPRING-M



## Triangular Ridge Bracket

Runs birdwire along roof ridges. Flexible base fits any angle or roof fridge. 3.5" post.  
BW-BRACKET-TRI



## Vertical Post & Wire Clamp

Stainless steel clamp used to install birdwire post to gutter bead, metal roof, or other vertical surfaces. 3.5" x 0.16"  
BW-CLAMP-V



## Horizontal Post & Wire Clamp

Stainless steel clamp used to install bird wire post to an I-beam or other horizontal steel surface. 3.5" x 0.16"  
BW-CLAMP-H



## Crimps (100 pack)

Attach Bird Wire to posts by threading it through crimps.  
BW-CRIMP



# More Bird Repellent Products

## Flock Reflector

Uses sunlight and wind to create flashing lights during daylight hours to deter seagulls and other migratory birds.

Can be screwed or glued into place, also can be mounted with suction. Stand has adjustable angle for a variety of positions.

**Aluminum and plastic design**

**FR**



## Bird Proof Gel

Surface repellent gel; tacky substance keeps birds off surfaces.

Discreet and low-profile, perfect for signs and entrances.

**12 tubes per case**

**BP-CART**



## Daddi Long Legs

Thin, stainless steel rods constantly move to interfere with birds' wings when they attempt to land. Design is unobtrusive and practically invisible from a distance.

**DLL-2**

**DLL-4**

**DLL-6**

**DLL-8**



## 4 The Birds: Repellent Liquid

Transparent, sticky liquid makes surfaces tacky and uncomfortable to birds.

**Gallon**

**BP-LIQ-1**



## Microbial Bird Dropping Cleaner

Designed to replace ordinary cleaners with a concentrated formula that is safe for any surface. Use with any power washer or hand sprayer.

**1 Gallon**

**MBDC-10**



## Bird Stop

Taste aversion, liquid bird deterrent with a smell and taste that birds avoid.

**Gallon**

**BS-GAL**



## Safety Solvent Cleaner

Safely cleans and removes Bird Proof Liquid and/or Gel from surfaces.

**Gallon**

**BPS-GAL**



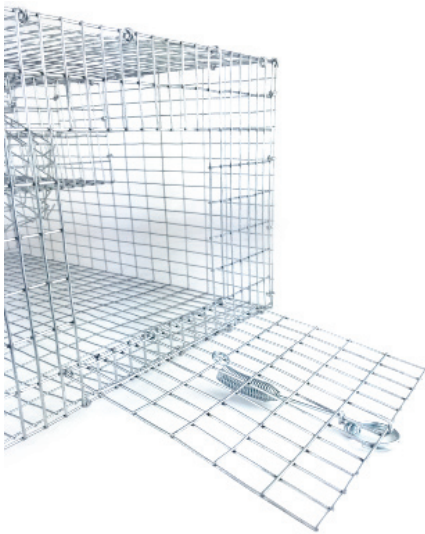

Multi-chamber traps come equipped with or without shade accessories and water or feed containers. Once birds enter, they cannot get back out the way they came. Birds move immediately to the elevated second level so they do not feel trapped, and will not emit distress calls. Access doors allow for easy removal of birds.

## Pigeon Traps

Shade, water & feed container included

**35" x 16" x 8"**

**PT3516/S/W/F**

Shade, water & feed container included

**46" x 24" x 10"**

**PT4624/S/1GW/F**

Shade included

**35" x 16" x 8"**

**PT3516/S**

Trap only

**35" x 16" x 8"**

**PT3516**

Collapsible to 1" high

**24" x 12" x 8"**

**PT2412/KD**

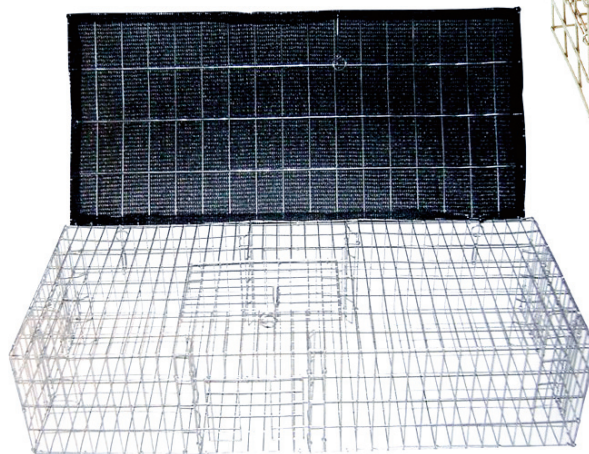
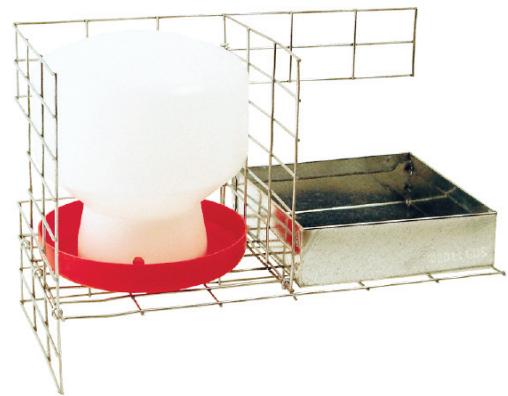

## Sparrow Traps

Trap only

**16" x 12" x 6"**

**SP2**

Water & feed container included

**36" x 24" x 10"**

**SP3/W/F**

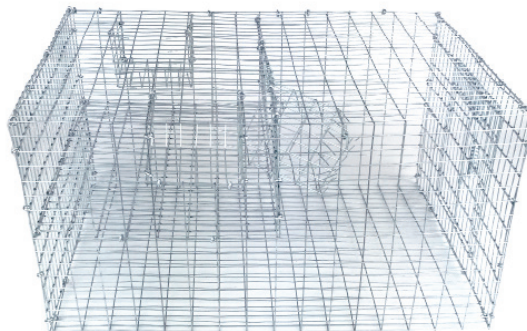

This cost effective and humane technology is especially useful for managing pigeon flocks in larger areas without having to resort to poisons and their associated risks.

## OvoControl P (nicarbazin 0.5%)

*Ready-to-Use Bait*



### OvoControl

- Reduces population by approximately 50% annually
- Ready-to-use contraceptive bait
- Will not harm pigeons, pets or other wildlife
- Designed specifically for pigeons and sparrows
- Battery & solar operated automatic feeder for roof available



**OvoControl P**  
per pound (for Pigeons)

**OVOP**

**OvoControl S**  
per pound (for Sparrows)

**OVOS**

**Large Tripod Feeder**  
30 gallon

**IN-12608**

**Large Tripod Feeder KIT**

Includes 30 gallon feeder, rechargeable battery and solar panel

**IN-12608KIT**

**Remote Camera M80XT KIT**

Includes IN-M880 camera, two (2 x 2GB) memory cards, tripod, card reader and batteries.

**IN-M880KIT**

Sonic bird control devices are easy to install, fully programmable, & extremely effective. Broadcast bird alarm calls & predator cries that condition pest birds to stay away from the area – one device covers multiple acres of land!

# Ultrasonic & Sonic Deterrents

## Super BirdXPeller PRO

*Outdoor, sonic pest bird repeller gets rid of birds in areas up to 6 acres.*

**SBXP-PRO-1** Version 1 repels: Pigeons, Starlings, Sparrows, & Gulls

**SBXP-PRO-2** Version 2 repels: Crows, Blackbirds, Grackles, Cormorants, & Ravens

**SBXP-PRO-WP** Version WP repels: Woodpeckers & Sparrows

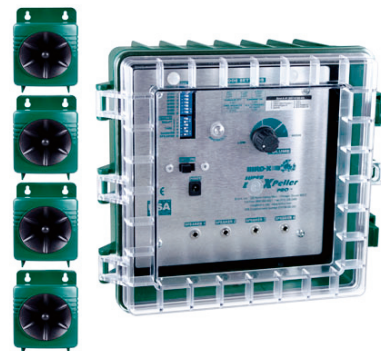

## BroadBand PRO

*Both sonic & ultrasonic bird repeller, covers up to 6 acres. Option to include 3 visual scares*

**BB-PRO**



## GooseBuster

*Sonic goose control device uses authentic recordings of Canada geese to deter geese & get rid of infestations. Covers up to 7 acres*

**GB**

## Solar Panel

*Solar panel converts sunlight into electricity and charges 12v batteries for DC (direct current) appliances. Works with Bird-X sonic devices*

**SOLPAN** 5-watt, 20" x 9" x 1"

**SOLPAN2** 5-watt, 37" x 16" x 1"



Ultrasonic bird repellers are simple to install, extremely low-profile, & highly effective. Repel pest birds discreetly & permanently using silent-to-humans ultrasonic sound waves! Ultrasonic technology is extremely irritating & disorienting to birds, but remains a safe, humane & eco-friendly option.

## Ultrason X

*Outdoor, ultrasonic pest bird repeller gets rid of birds in areas up to 3,600 sq. ft.*

**USX**

## ECC Floating Ball Blankets

*Covers the surface area of water and wastewater applications*

## Bird Balls



ECC Bird Balls provide several advantages over other systems:

- Reduction of liquid loss through evaporation by up to 90%
- Reduced chemical consumption
- Improved working environments
- Allows movement of equipment through the liquid
- Eliminates algae and weeds by blocking the sunlight UV rays
- Balls spread automatically as the liquid levels rise and fall
- Reduced heat loss maintains biological reactions during cold weather





# Control Pest Birds Indoors

*Lasers constantly change patterns to prevent acclimation.*



## Laser Bird Control

### Remote controlled Fat Beam technology safely frightens birds away!

Laser Bird Control is a well-documented way to chase away pest birds without sound. The lasers and patterns change constantly to prevent acclimation. The beam seeks out their roosting-spots, alarming and confusing them, causing them to flee. Laser Bird Control is a humane & eco-friendly solution.



**BX-LASER-IN**



**BX-LASER-OUT**



#### Indoor/Outdoor Laser Specifications:

- Laser color: Red + green
- Net Weight: 1.5kg
- Power: AC100-240V, 50-60Hz
- Electric Current: 100mA
- Classification: CLASS 3R
- Fuse: 2A
- Housing: Cast aluminum
- Beam Divergence: 60°



**Mounting base included**

# Autonomous Flight

## Maximum Bird Control Effectiveness

*The latest Bird Control Technology*

# ProHawk UAV Drone



**Ideal for commercial applications where a falcon or other manual drone device would be used.**

- Saves time and money
- Simple to use, implement, and operate
- Professional solution for tailored, individual situations

The first drone of its class made specifically for bird control. The ProHawk™ UAV combines a sonic bird repeller with the latest autonomous flight GPS technology and design. Patented design, Made in USA.

- Fully Autonomous Flight - once programmed, simply set unit outside and hit start
- The unit will launch, patrol, and land on its own
- Set “waypoints” to perfectly customize patrol areas via GPS technology
- Terrifying physical presence is heightened by sonic predator sounds
- Camera options available
- Professional-grade carbon fiber construction
- Save hours of labor and thousands of dollars





Bird-X, Inc.  
300 N Oakley Blvd.  
Chicago, IL 60612  
USA



*Bird-X works closely with professional installers and PCO's on projects of all sizes. We understand the urgent and competitive nature of the industry, and we're here to help.*

*From initial bidding support to product training and custom consultations, your dedicated account manager will take care of you promptly with expert advice and information.*

*Please contact us and let us know what you need.*

1.800.662.5021 • 312.226.2473 • [www.bird-x.com](http://www.bird-x.com)