

CONTECH
intelligent animal control

ScareCrow

M A N U A L

english p3

français p11

español p19

nederlandse p27

deutsch p35

italiano p43

<http://www.scatmat.com>

CE



Owner's Manual

- *Cautionary Reminders* (p. 3)
- *Assembly Guide* (p. 4)
- *Setting Sensitivity* (p. 6)
- *Adjusting Water Coverage* (p. 7)
- *Troubleshooting* (p. 9)

Manuel de l'Utilisateur

- *Des Rappels d'Alertes* (p.11)
- *Guide D'Assemblage* (p.12)
- *Ajustement de Sensibilité* (p.14)
- *Ajustement de Couverture de l'Eau* (p.15)
- *Dépannage* (p.17)

Manual del Usuario

- *Precauciones* (p. 19)
- *Guía de ensamblado* (p. 20)
- *Regulando la sensibilidad del sistema* (p. 22)
- *Ajustando la cobertura del agua* (p. 23)
- *Resolución de problemas* (p.25)

Gebruikshandleiding

- *Waarschuwingen* (blz. 27)
- *Montagegids* (blz. 28)
- *Instellen van de Gevoeligheid* (blz. 30)
- *Afregelen van het Waterbereik* (blz.31)
- *Foutopsporing* (blz. 33)

Benutzer Handbuch

- *Vorsichtshinweise* (p. 35)
- *Montageanleitung* (p. 36)
- *Einstellung der Empfindlichkeit* (p. 38)
- *Einstellung der Wasserabdeckung* (p. 39)
- *Problemlösungen* (p. 41)

Manuale Utente

- *Indicatori di pericolo* (p. 43)
- *Giuda assemblaggio* (p. 44)
- *Impostazione della sensibilità* (p. 46)
- *Copertura regolazione acqua* (p. 47)
- *Ricerca ed eliminazione di guasti* (p. 49)

Thank you for purchasing this Contech product.

What you will need



Alkaline



Cautionary Reminders

Malfunctioning sprinklers carry an inherent risk of causing water damage to your property. Mitigate your risks by limiting the amount of water available to the unit (open valve 3/4 turn), employing good quality hoses and ensuring your water pressure is within the normal operating range of the unit.



Intended to operate between 30 and 80 psi (2-5.5 Bar). Install a pressure-reducing valve on tap if your water pressure exceeds 80 psi. Opening your tap part way does NOT change the water pressure.



When pushing the stake into the ground, use the footstep at the hose connection point. Do not push down or apply weight on the sensor housing.



Before disconnecting the unit or the hose, always turn water off and activate the unit with your hand to reduce line pressure in the hose.



To prevent damage from freezing water, take the Scarecrow inside and remove the battery before the first winter frost.



Dust, dirt or hard water build-up on the white lens will limit sensitivity. Keep the lens clean by wiping gently with a damp cloth.



The eye on the Scarecrow decal may frighten small birds.

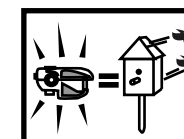
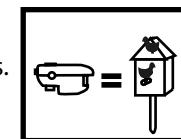

To minimize false triggering, avoid pointing at moving water, windy areas and moving vehicles.

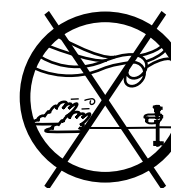

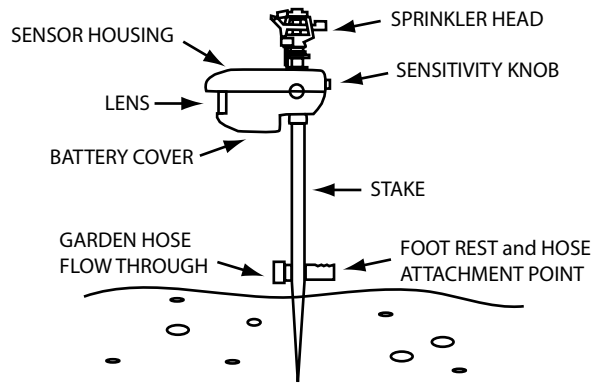

Scarecrow Assembly Guide

If you encounter any problems while assembling your Scarecrow, please refer to the Troubleshooting section, or call us at 1.800.767.8658 or 1.250.652.0755 or email support@scatmat.com.

1. Examine the contents of the Scarecrow package.

Your Scarecrow package includes:

A. Owner's manual with warranty registration and survey

B. Sprinkler

C. Sensor housing

D. Stake Top

E. Stake Bottom

F. Scarecrow Decal Sheet (Optional)

G. Flow through cap

H. Quick Connect coupling (Optional)

OPTIONS: Scarecrow's beak and eye decals may be applied now. The Quick Connect coupling is only for use with hoses that have quick connects.

2. Open battery cover and install 9 volt battery.

The battery cover is located under the sensor housing.

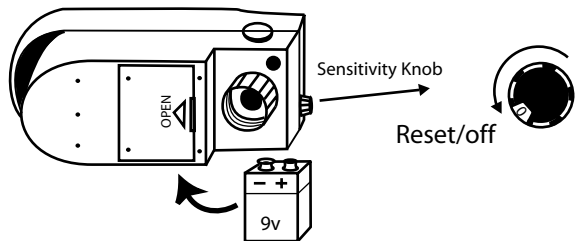

3. Check Scarecrow operation. (Dry test).

First, turn the sensitivity knob to 4 or 5. Next, wave your hand in front of the sensor lens. You should easily hear the Scarecrow's internal water valve click open, then click closed 3 seconds later. There is an 8 second reset interval after the valve closes when the sensor does not detect motion.

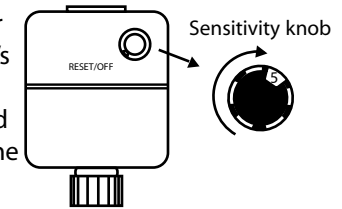

⚠ If you hear no clicking, try a new battery and try hooking your Scarecrow up to water. If the problem persists, call the factory toll-free at 1.800.767.8658 / 1.250.652.0755 for assistance or email: support@scatmat.com

4. Assemble stake and attach sprinkler head and stake to housing.

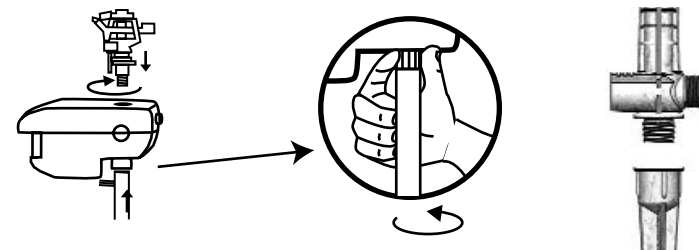

These fittings should only be hand tightened.

5. Connect hose and position the Scarecrow.

Aim the Scarecrow towards the area you want to protect. Push the spike into the ground by stepping on the footrest.

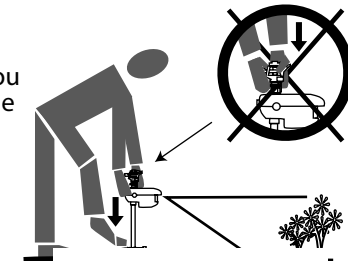

Do not push on the sensor housing or sprinkler head. If the ground is too hard or otherwise unsuitable for the plastic stake, try placing the Scarecrow in a flower pot filled with a weighted material like sand or gravel

Multiple Connections

If you have more than one Scarecrow you can hook them up in series by removing the flow through cap and connecting them as shown below.

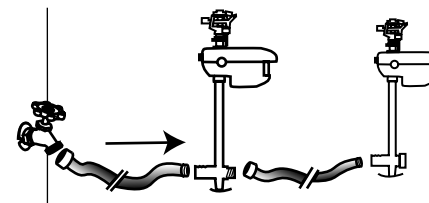

Setting Sensitivity



If you can hear the Scarecrow's clicks from 10 meters (35 feet) away, you do not need to turn on the water for this section. In a noisy area where the audible clicks cannot be heard each time you move, please turn the water on for setup purposes. If you decide to turn the water on for your setup process, just point the water spray to one side to avoid getting wet.

1. Turn the sensitivity knob on.

Sensitivity Knob



RESET / OFF

Set the sensitivity knob high enough to see to target animal when it is within reach of the 10 meter (35 foot) water spray, but not beyond that point. It is not beneficial to sense animals or moving objects outside the area you wish to protect.

2. Confirm sensing area.

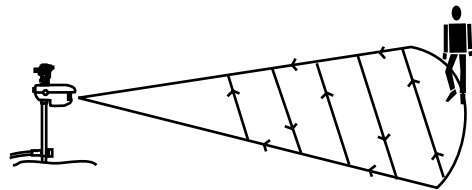

The Scarecrow is most sensitive to movement across the field of view. Motion towards or away from the sensor may not always trigger the unit.

Start outside your desired coverage area and work your way inwards. The Scarecrow's sprinkler will activate once it detects you. Make minor adjustments until you feel the Scarecrow will only trigger when movement is detected inside the you wish to protect. After the 3 second pulse of water, remain still for approximately 8 seconds after each activation, while the Scarecrow resets itself. Repeat this process until you have a good idea of the Scarecrow's area of coverage at this setting.

3. Increase or decrease the Scarecrow's sensitivity

Suggested sensitivity settings

Distance at which you wish to detect animal.

Animal Size	10 ft.	20 ft.	30 ft.
Small	6-7	7-9 *	
Medium	3-4	5-6	7-9
Large	2-3	4-5	6-9

* Some small animals might not be seen at this distance.

Adjusting Water Coverage.

After you have set the Scarecrow's sensitivity and positioned it securely with its lens aimed at the desired area, use this section to help you adjust the arc and distance of the Scarecrow's water spray.

Make sure the water is turned OFF, then follow the steps below.

1. Position stem tabs to adjust sprinkler travel.

Position the stem tabs so the metal wire clip travels between these tabs and faces the area to be sprayed. Stem tabs determine the arc range of the Scarecrow from 0 to 300 degrees.

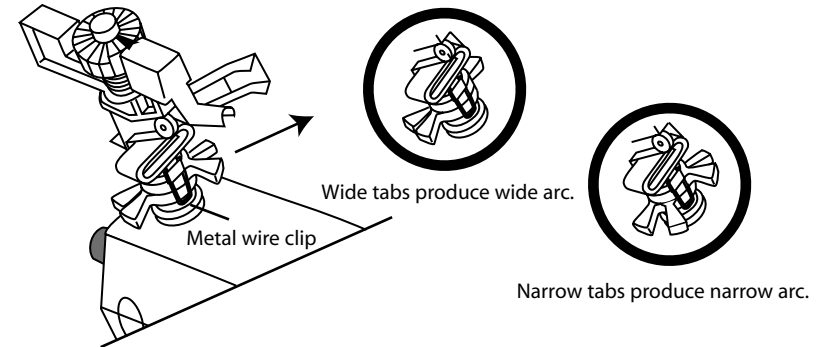

2. Adjust the distance of water spray

Raise or lower the water deflector dial to control the distance of the water spray.

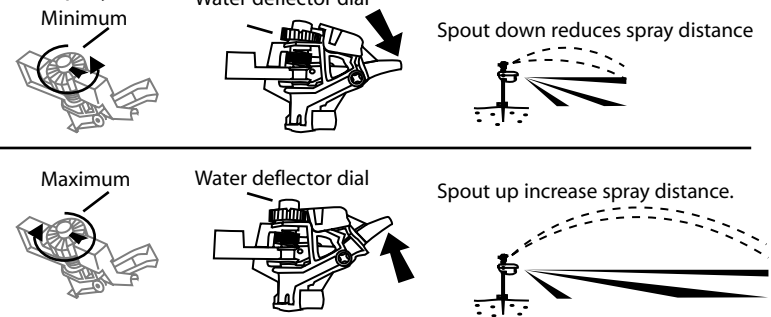

3. Turn the water ON and test from behind.

The Scarecrow should activate. Adjust the arc and distance to suit your needs.



How the Scarecrow Works

The Scarecrow protects any open area of the garden or yard that receives the unwanted attention of animals. Its sprinkler directs water accurately up to 10 m (35 feet), protecting a 90 square meter (1000 sq. ft.) area. The Scarecrow can see large animals farther away than it can small animals.

The Scarecrow uses a passive infrared sensor to see the temperature difference between an animal and the background. However, if the animal and the background are similar temperatures the Scarecrow will have difficulty detecting movement.

When an animal or person moves into the field of view, the Scarecrow notices the change and opens an electronic valve to release a 3 second burst of water through the sprinkler. The Scarecrow then pauses for 8 seconds before resuming sensing. This pause creates an element of randomness and unpredictability preventing animals from becoming used to the device.

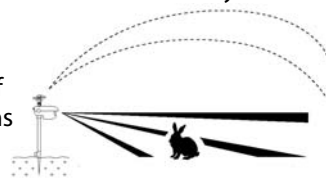



Sensing Area

The sensing area consists of several dozen alleyways through which an animal must cross to be detected.

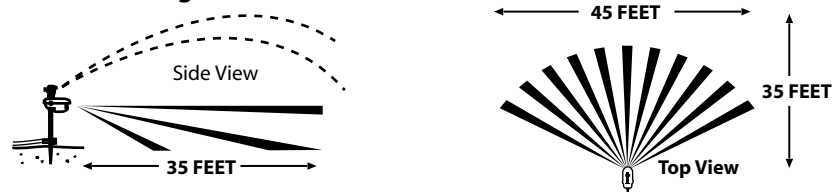
Detection Range



 Animals like rabbits, cats and squirrels may cross under the sensor alleys. The sensor will eventually see them. Larger animals and people are seen the easiest.

 The chart on page 4 shows suggested settings for various animals.

Sensitivity Auto Adjust

Nuisance or false triggering shortens battery life. When this happens the Scarecrow will automatically reduce its sensitivity within five minutes (except for a 1 hour period when the battery is first connected or sensor knob is adjusted.) False activations are most noticeable during windy conditions.

Troubleshooting

If you encounter a problem no covered here, or if these suggestions don't solve your problem, please refer to the detailed Troubleshooting section of our website at www.scarecrowinfo.com or email us at support@scatmat.com or call us at 1.800.767.8658 / 1.250.652.0755

The Scarecrow seems to have erratic sensitivity.

This could be due to the Scarecrow's auto adjust circuit. Turn the sensitivity knob to the OFF (0) position for two seconds. This resets the auto adjust circuit. If this does not work, ensure the Scarecrow's lens is clean by wiping it with a soft damp cloth.

The Scarecrow does not 'see' animals.

Re-aim the Scarecrow. Refer to figure 2 on page 6 of this manual. If this does not work, ensure the Scarecrow's lens is clean by wiping it with a soft damp cloth.

The Scarecrow only 'spits' water or makes a "pinging" sound..

This indicates the battery is low or your water pressure is too high. Replace the battery or add a pressure reducer to the water supply.

The Scarecrow leaks water through its sprinkler.

Debris is lodged in its fittings. Remove the sprinkler head and stake. Backflush water through the valve in the sensor head to dislodge the debris.

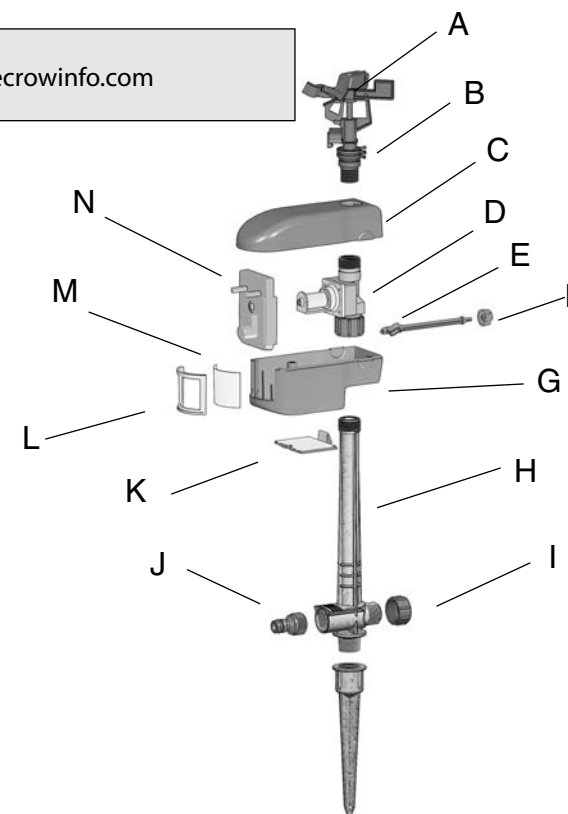
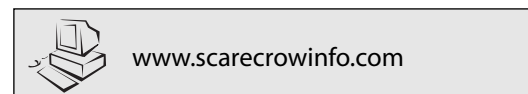

Scarecrow Guarantee

All Contech Electronics, Inc. products are backed by a 30-day money back guarantee. If your Scarecrow does not meet your expectations, return it to where it was purchased, in new condition within 30 days of receipt for a full refund of the purchase price.

Scarecrow 2 Year Warranty

Contech Electronics, Inc. warrants to the original purchase of its products that the product will be free from defects in material and workmanship for a period of two (2) years. This warranty does not cover damage caused by or attributable to acts of God, abuse, misuse, improper maintenance, or damage caused in transportation.

Contech Electronics, Inc. is not responsible or liable for indirect, special, or consequential damages arising out of or in connection with, the use of this product, or damages with respect to any economic loss, loss of property, or loss of revenues or profit.

Except as provided herein, Contech Electronics, Inc. makes no express warranties, and denies any implied warranty or merchantability or fitness for a particular purpose. Charges will be rendered for repairs to the product after the expiration of the aforesaid warranty period. This warranty may not be transferred.

To activate your warranty, please return the warranty registration portion of these instruction by fax or mail. We welcome your comments and experiences with the Scarecrow on our website at <http://www.scatmat.com>

Return Policy

We want you to be pleased. If something isn't right, call us toll free at 800-767-8658. If we can help you over the phone we will, and if not we will give you a return authorization number and shipping instructions. When we receive your package we will repair, replace or promptly issue a refund at your option if purchased directly from Contech. Unauthorized returns will not be accepted. Refunds can only be made by the retailer transacting your purchase. Please call before sending any package.

Questions?

Fax your question toll free, visit our Web site online at www.scatmat.com or call us between 8:00 and 4:30 Pacific Standard Time.
Contech Electronics, Inc. 6582 Bryn Rd Victoria, BC Canada



Customer Service: (250) 652-0755 or 800-767-8658



Fax: (250) 652-5351 or 800-876-1666



NOTE! The Scarecrow may false trigger under certain high frequency electromagnetic interference conditions.

Copyright© 1999 Contech Electronics Inc. Content may not be reproduced without the express written permission of Contech Electronics Inc. Stylized Scarecrow and Contech logo are registered trademarks of Contech Electronics Inc. All rights reserved.

Veillez lire les présentes instructions avant toute utilisation.

Merci d'avoir acheté ce produit Contech.

Ce qu'il vous faut :



Alcaline



Rappels des précautions

Les anomalies de fonctionnement des arroseurs risquent de provoquer des dégâts d'eau à votre propriété. Minimisez vos risques en limitant la quantité d'eau disponible pour votre appareil (ouvrez la vanne du tuyau de trois quarts de tour au maximum),



Pression de fonctionnement entre 30 et 80 psi (entre 2 et 5,5 bars). Installez une vanne de réduction de pression sur le robinet si votre pression d'eau dépasse 80 psi. Ouvrir votre robinet à moitié ne changera PAS la pression de l'eau.



Lorsque vous enfoncez le pieu dans le sol, utilisez la crapaudine au point de raccord des tuyaux. Ne pas vous appuyer ou mettre du poids sur le boîtier du capteur.



Avant de débrancher l'appareil ou le tuyau, coupez toujours l'arrivée d'eau et activez l'appareil à la main pour réduire la pression de canalisation dans le tuyau.



Pour empêcher les dommages causés par l'eau gelée, mettez le Scarecrow à l'intérieur et enlevez la pile avant le premier gel d'hiver.



Toute accumulation de poussière, d'impuretés ou de calcaire sur la lentille blanche limite la sensibilité. Maintenez la propreté de la lentille en la nettoyant délicatement avec un tissu humide.



L'œil sur l'autocollant Scarecrow peut effrayer les petits oiseaux.

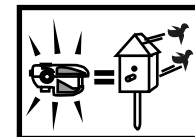
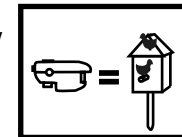

Pour minimiser un déclenchement intempestif, évitez de pointer vers de l'eau motrice, des zones exposées au vent et des véhicules en mouvement.



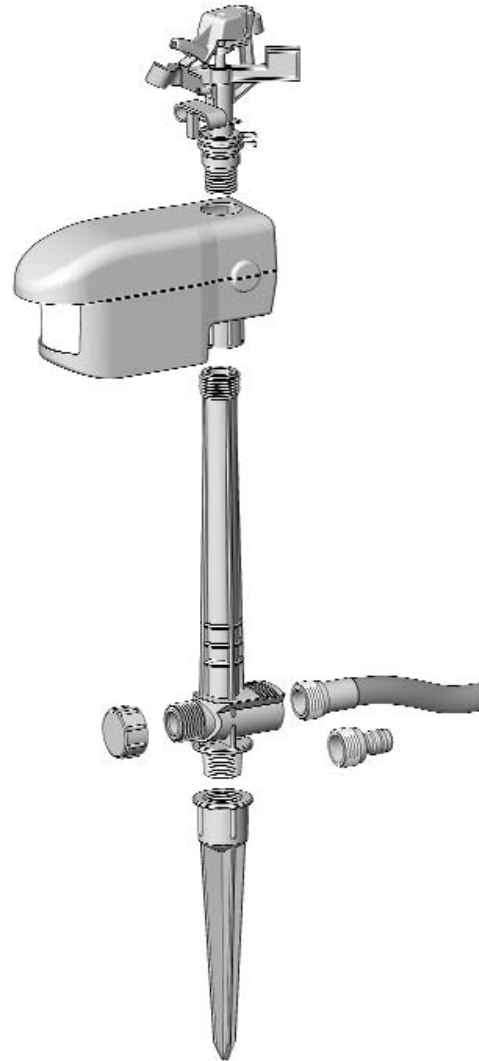

CONTECH
intelligent animal control

Contech Electronics, Inc.

P.O. Box 115 Saanichton, BC Canada V8M 2C3

Customer Service: (250) 652-0755 or 800-767-8658

Fax: (250) 652-5351 or 800-876-1666